

NERA

The most compact
and reliable solution
for solar pumping
applications



THINK TO INNOVATE

lapsrl.it

NERA solar pumps have been developed to meet the needs of low-power and low-cost pumping systems without sacrificing quality, reliability and performance.

For this reason, unique technological features are concentrated in NERA.

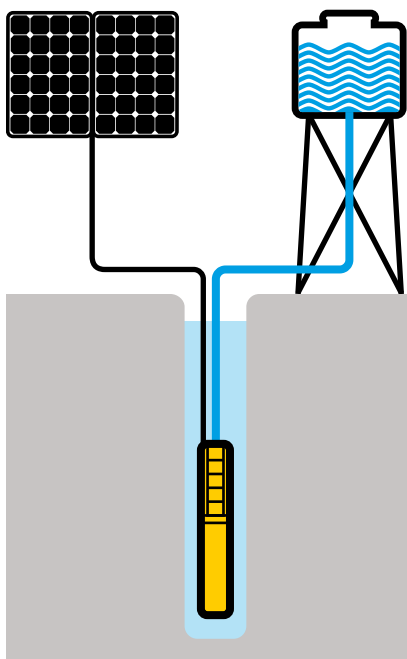

Centrifugal pump

- Impellers and diffusers in AISI 304 stainless steel
- Built-in no return valve

Encapsulated electronics

- High-efficiency encapsulated inverter
- MPPT for maximum flow in all weather conditions
- Overload, overheating and dry-run protected
- Removable power cable
- Water level sensor





Helical rotor pump

- Highest hydraulic efficiency
- Hard chromed rotor
- High quality EPDM stator

Motor

- High efficiency permanent magnet motor
- Resined and encapsulated stator made of AISI 304 stainless steel
- Water-cooled rotor
- Kingsbury thrust bearing

To connect NERA to the solar system, the STOP MODULE device is available as an accessory. It is equipped with:

- MC4 connectors for fast and easy panels connection
- Button for pump start and stop
- Connection for float or pressure switch
- Surge protection

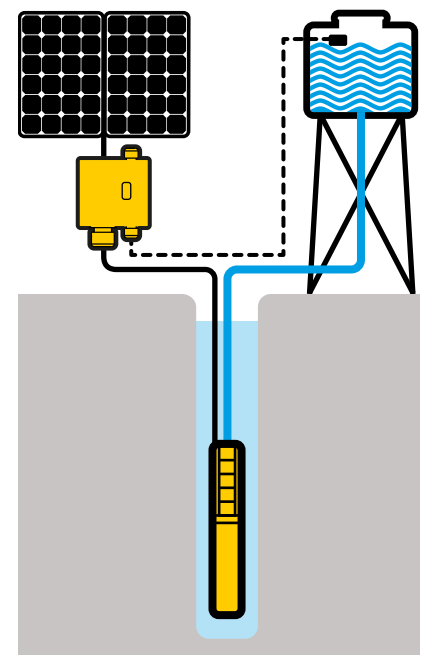

MPPT: always the maximum power available

Based on the varying conditions of solar irradiation and temperature, MPPT (Maximum Power Point Tracking) maximises the electrical power drawn from the panels and therefore the amount of water pumped. The greater the solar irradiation the faster the pump's rotation speed, and consequently water flow increases.

When solar irradiation decreases (due to clouds or the different times of day), the pump reduces frequency and therefore the flow, but it continues to provide water until the irradiation falls below a minimum level necessary to ensure operation.

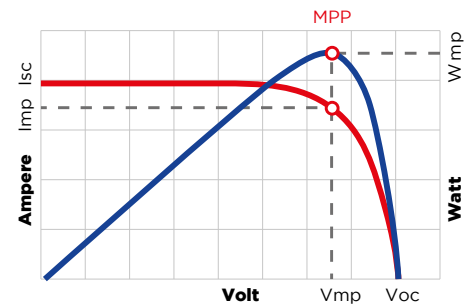

Pump selection

For the correct selection of NERA pump to be used in a photovoltaic system, it is necessary to know:

- Desired daily water flow
- Total head
- Installation location

Based on the location it is possible to calculate average daily radiation [kWh/m²/day]. Average daily radiation can then be considered as the number of hours the pump works with

1 kW/m², standard for defining solar panel performance. Dividing the required water quantity by the hours, nominal flow

is calculated and, in addition to the required head, the right pump can be selected.

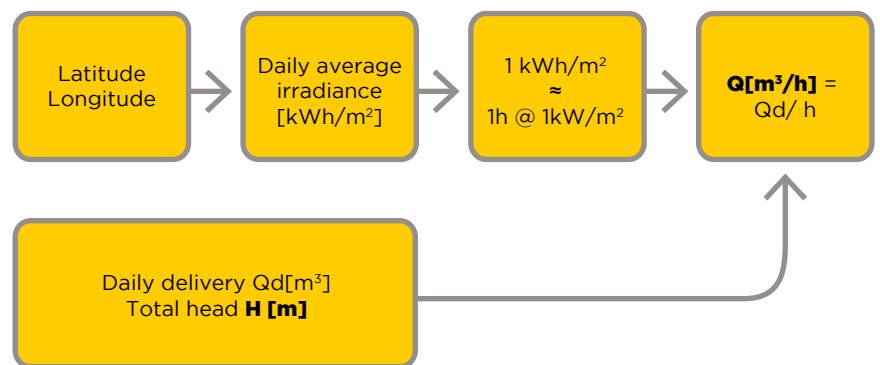

Performance

NERA 01/02H

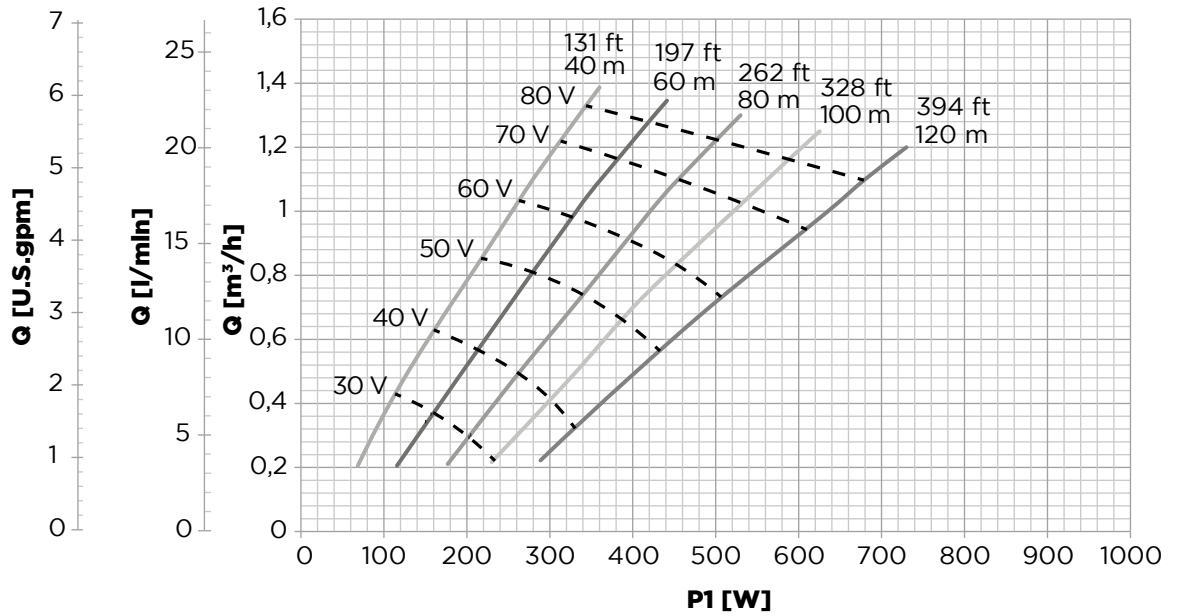

NERA 02/01H

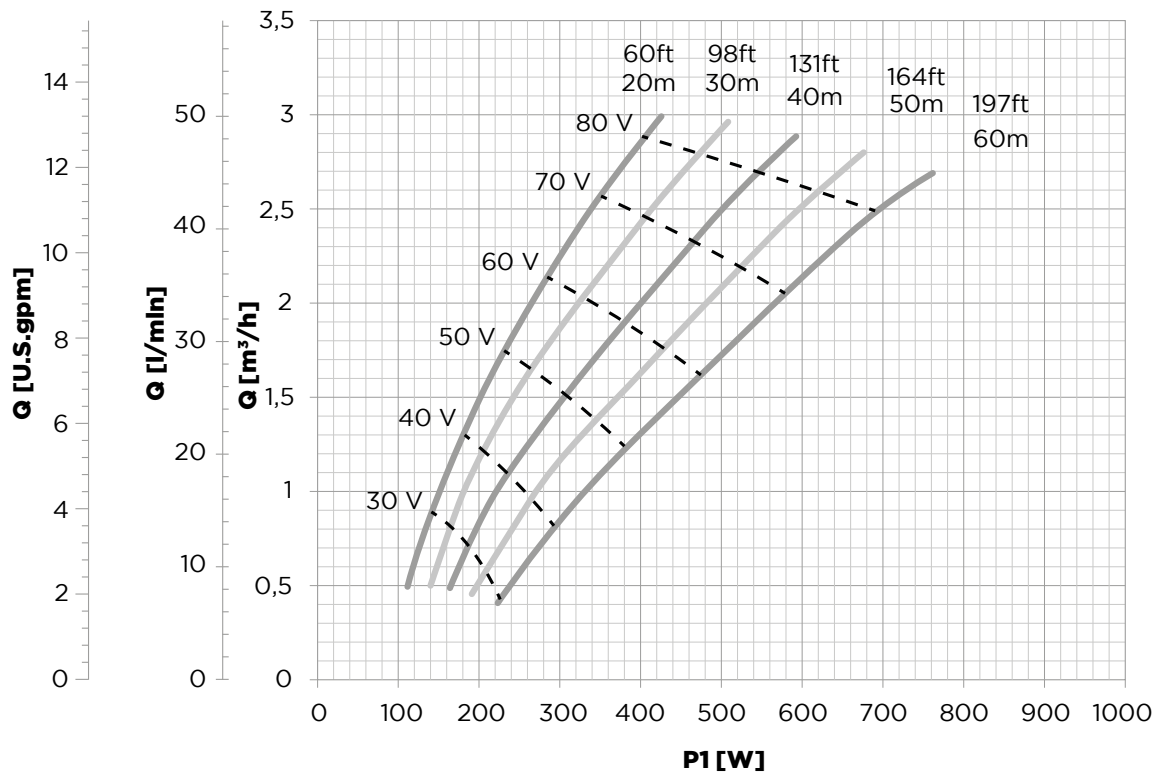

Model	Voltage	Max current	Max power	Length	Discharge	Pump weight	Max diameter*	Packing dimensions	Total weight
NERA	[VDC]	[A]	P1 [W]	[mm]		[kg]	[mm]	[cm]	[kg]
01/02H	26 - 190	10	800	930	1 1/4 "	11	99*	77x21x26	13
02/01H	26 - 190	10	800	890	1 1/4 "	10	99*	77x21x26	12

* Max external diameter including cable and cable cover

Performance

NERA 06/04

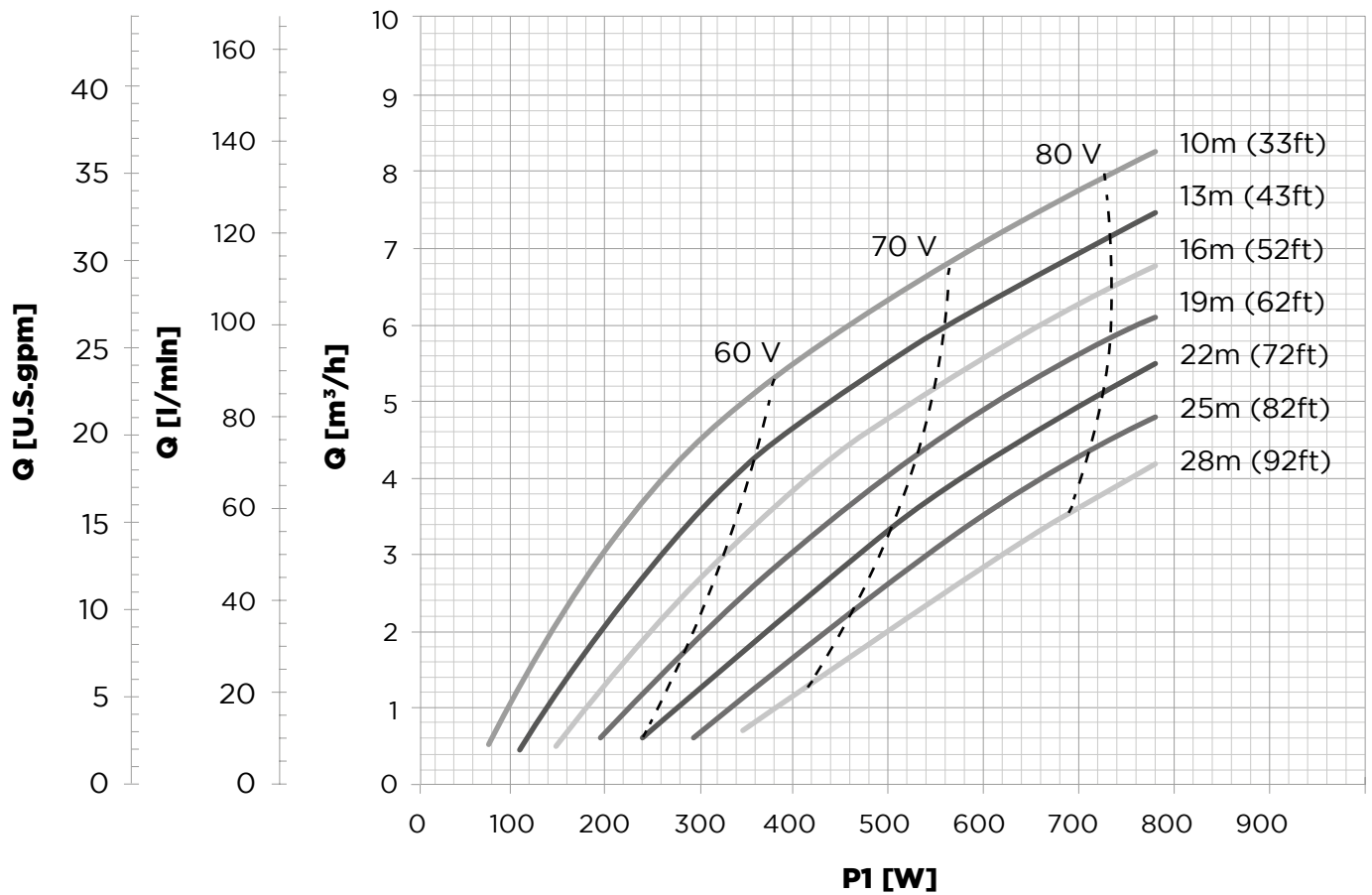

Model	Voltage	Max current	Max power	Length	Discharge	Pump weight	Max diameter*	Packing dimensions	Total weight
NERA	[VDC]	[A]	P1 [W]	[mm]		[kg]	[mm]	[cm]	[kg]
06/04	26 - 190	10	800	520	11/2 "	9	99*	57x21x26	11

* Max external diameter including cable and cable cover

General specifications

Max liquid temperature	35 °C (92 °F)
Min liquid cooling speed	0.2 m/s
Characteristics of the pumped liquid	clean, chemically not aggressive, not explosive, without solid and fibre content, with max 50 g/m ³ sand content
Protection degree	IP68
Maximum immersion depth	150 m
Materials	Motor and pump in AISI 304 stainless steel
Cable	Flat cable ACS - WRAS - KTM approved
Certifications	CE

Materials

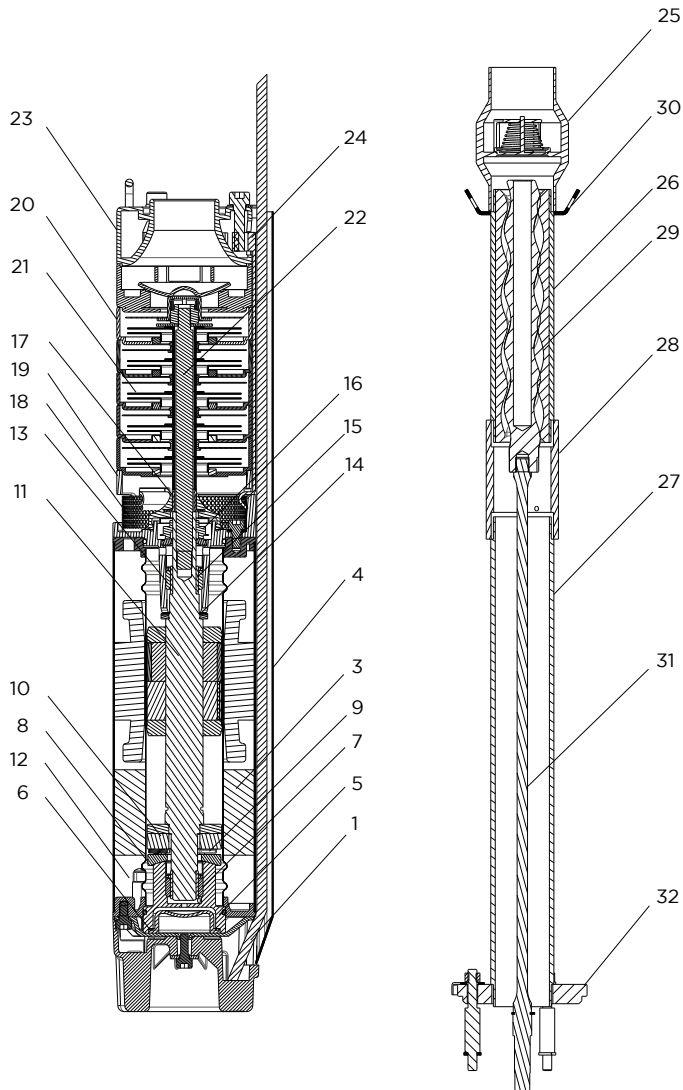

Ref	Description	Material
1	Power supply cable with removable connector for drinking water applications	AISI 304 + ACS-KTM-WRAS compliant
3	E-Ring: Encapsulated inverter module	
4	Cable guard	AISI 304
5	Lower thrust bearing	AISI 304
6	Rubber diaphragm	EPDM
7	Lower bush	SiC
8	Tilting disc	AISI 304
9	Pads	AISI420j
10	Carbon disc	CTI25
11	Shaft with rotor	AISI 431
12	Canned type stator	AISI 304
13	Upper bush	SiC
14	Upper thrust bearing	Teflon
15	Ceramized sleeve	AISI 304 + Ceramic
16	Mechanical seal	SiC
17	Rotating sandguard	NBR
18	Pump filter	AISI 304
19	Pump bracket	AISI 304
Centrifugal pump		
20	Diffusers	AISI 304
21	Impellers	AISI 304
22	Pump shaft	AISI 304
23	Discharge	AISI 304
24	Straps	AISI 304
Helicoidal rotor pump		
25	No-return valve	AISI 304
26	Helicoidal stator	EPDM + AISI 304
27	Supporting pipe	AISI 304
28	Junction	AISI 304
29	Helicoidal rotor	AISI 316 cromed
30	Safety hook	AISI 304
31	Flexible shaft	AISI 316
32	Pump adaptor	AISI 304



THINK TO INNOVATE

✉ info@lapsrl.it
🌐 www.lapsrl.it

Italy, Vicenza